

# ProFlex Covers made of Aluminum Profiles



**STEINBOCK GmbH**  
Industrie-Ausrüstungen • Industrial Components

## Dimension sheet and request form

- A** Series **AL-K** (Alu Profiles with PU hinges)
- B** Series **AL-S** (Interconnected alu profiles)
- C** Series **AL-SL** (Light covers)

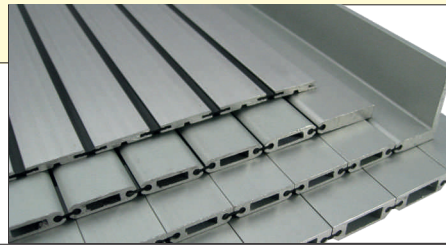

- Light
- Inexpensive
- Fast delivery

### **A** Series **AL-K - Profiles with hinges**

The precision profiles are anodised in natural color and are positively connected with a highly tear-resistant polyurethane hinge. This creates an oil and coolant resistant surface and prevents the penetration of liquids and chips.

#### **AL-K3**

Our Smallest

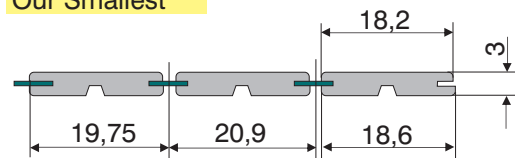

Type	Thick-ness mm	Min. radius mm	Bendable to both sides mm
AL-K3	3	11	yes
AL-K5-R	5,5	25	yes
AL-K5-F	5,5	25	no
AL-K8	8	25	no

Mounting option

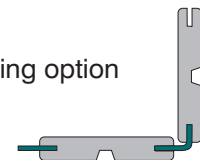

#### **AL-K5-R**

Our Bestseller (with rounded profiles)

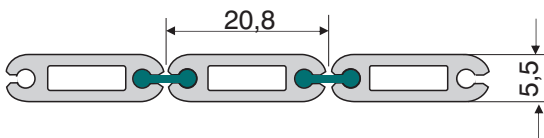

Solid end piece

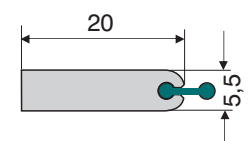

#### **AL-K5-F**

With flat profiles = even surface

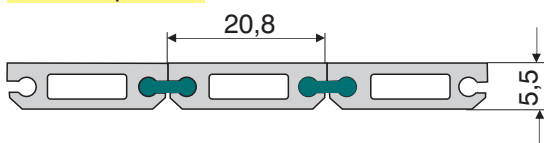

Optional with side caps, e.g. as slide shoes for frontal use.

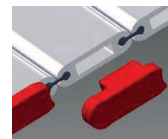

Angle

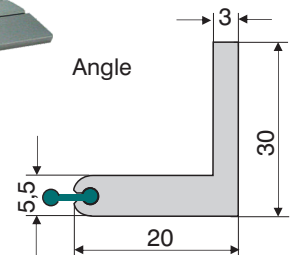

Can be cleaned with wipers\*

#### **AL-K8**

With flat profiles = even surface

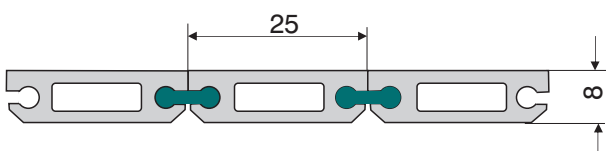

Optional with side caps, e.g. as slide shoes for frontal use.

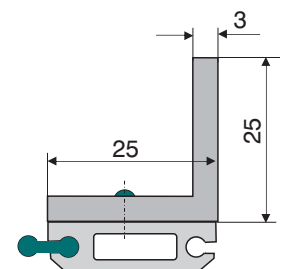

Can be cleaned with wipers\*

All ProFlex Covers can be supplied with a **winding mechanism** (spring shaft or motorized), with **metal housing** and with **visual apertures**. We use this material also for **roll-up doors**, which we manufacture to your specifications. Please inquire with a sketch or drawing!

\*Slightly slanted positioned

# ProFlex Covers made of Aluminum Profiles

## Dimension sheet and request form



**STEINBOCK GmbH**  
Industrie-Ausrüstungen • Industrial Components

- Light
- Inexpensive
- Fast delivery

### B Series AL-S - Interconnected profiles

ProFlex Covers with interconnected profiles are available in thicknesses of 7, 14 and 25 mm. The profiles of the cover AL-S7 are caulked against slipping sideways. The profiles of the covers AL-S14 and AL-S25 are locked by lateral rivets and are simple to extend or to shorten. When damaged, the profiles can be interchanged. The covers are suitable also for **laser** use. Also available as **walk-on version**, e.g. as **pit covers**. Motors, connectors, sensors on request.



**AL-S7**  
**AL-S14**  
**AL-S25**

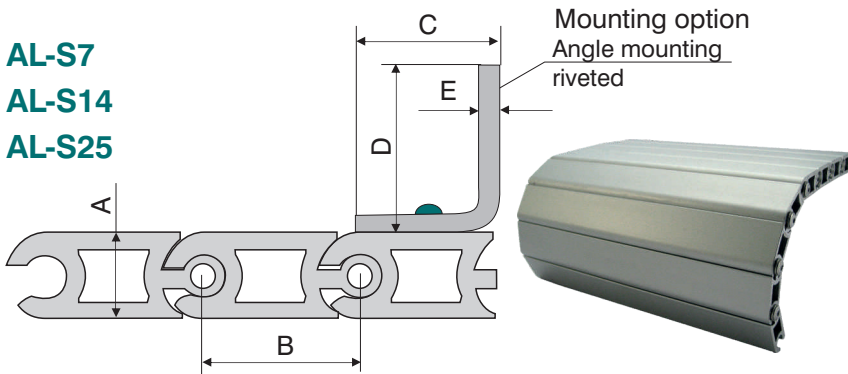

Type	A mm	B mm	C mm	D mm	E mm	min. Radius mm
AL-S7	7	18,2	19	19	3	31
AL-S14	14	25	25	25	3	35
AL-S25	25	50	50	25	3	100

### C Series AL-SL - Light version cover

When you need a simple and inexpensive protection, this light version cover is the answer. The ProFlex light version cover consists of half segment alu slats which are riveted on a highly tear-resistant carrier tape. Other slat materials like steel or brass on request.

**AL-SL**

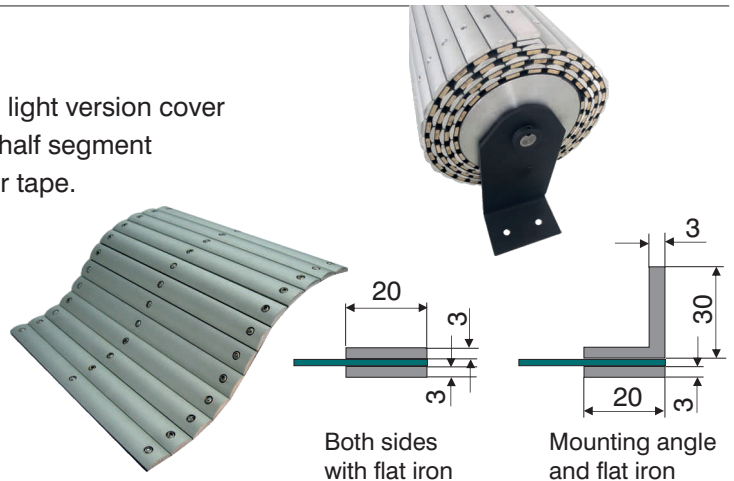
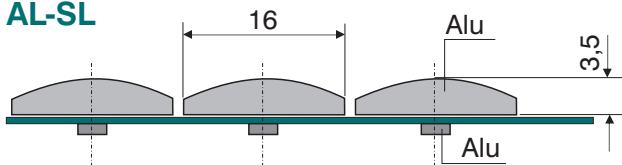

Both sides  
with flat iron

Mounting angle  
and flat iron

For quoting we ask you to specify:

**INQUIRY**

1. Type of profile (e.g. AL-K5-R) \_\_\_\_\_
2. Length \_\_\_\_\_ mm      3. Width \_\_\_\_\_ mm
4. What kind of mounting?    Angle     Solid end piece     Flat iron
5. Other requirements (e.g. as roll-up cover) \_\_\_\_\_
6. Quantity:    Single piece     Series \_\_\_\_\_ units

For designs with **visual apertures** and for **roll-up doors** please add a drawing/sketch. Thank you!

Name of company \_\_\_\_\_

Street \_\_\_\_\_

Contact person \_\_\_\_\_

Phone/Fax \_\_\_\_\_

City, Country \_\_\_\_\_

E-Mail \_\_\_\_\_

Please send this request form by fax to +49 89 999 399-85 or by E-Mail to [info@steinbock-industrie.de](mailto:info@steinbock-industrie.de)